





Messrs.					
Product Specification	Model:	MTF-TV57NP721-AV	Rev. No.	Issued Date.	Page.
			B	Oct .16, 07	1 / 29

LIQUID CRYSTAL DISPLAY MODULE
MODEL: MTF-TV57NP721-AV
Customer's No.:

Acceptance

Microtips Technology Inc.
12F. No.31 Lane 169, Kang Ning St.,
Hsi-Chih, Taipei Hsien, Taiwan
FAX: 886-2-26958625

Approved and Checked by

Approved by	Checked by		Made by
			



Microtips Technology Inc.

Messrs.					
Product Specification	Model:	MTF-TV57NP721-AV	Rev. No.	Issued Date.	Page.
			<i>B</i>	<i>Oct .16, 07</i>	<i>3 / 29</i>

Contents

1.	GENERAL DESCRIPTION AND FEATURES	4
1.1	Features.....	4
1.2	General Specifications	4
2.	INPUT TERMINAL PIN ASSIGNMENT	5
2.1	Pin Assignment	5
2.2	Back-light Unit (BLU).....	6
2.3	Touch Panel Pin Assignment	6
3.	BLOCK DIAGRAM	7
4.	OPTICAL CHARACTERISTICS	8
5.	ABSOLUTE MAXIMUM RATINGS	11
5.1	Absolute Ratings of Environment	11
5.2	Electrical Absolute Maximum Rating	11
6.	ELECTRICAL CHARACTERISTICS	12
6.1	DC Electrical Characteristics.....	12
6.2	AC Timing Characteristic of The LCD	13
7.	BACKLIGHT SPECIFICATIONS	15
7.1	Absolute Maximum Ratings	15
7.2	Electrical/ Operating Characteristic	15
8.	DISPLAYED COLOR AND INPUT DATA	16
9.	QUALITY STANDARD FOR LCD	17
9.1	Objective.....	17
9.2	Scope	17
9.3	Inspection specification	19
10.	RELIABILITY CONDITION FOR LCD	22
10.1	Reliability Test Condition.....	22
10.2	Operating Test Pattern	22
10.3	Touch Panel Reliability	24
11.	PRECAUTIONS	25
11.1	Operation	25
11.2	Safety	25
11.3	Handling	25
11.4	Static electricity	27
11.5	Storage	27
11.6	Cleaning.....	27
11.7	Waste.....	27
12.	WARRANTY	28
13.	DIMENSIONAL OUTLINES	28



Messrs.					
Product Specification	Model:	MTF-TV57NP721-AV	Rev. No.	Issued Date.	Page.
			<i>B</i>	<i>Oct .16, 07</i>	<i>4 / 29</i>

1. GENERAL DESCRIPTION AND FEATURES

MTF-TV57NP721-AV is a TM (Transmissive) type color active matrix TFT (Thin Film Transistor) liquid crystal display (LCD) that uses amorphous silicon TFT as a switching device. This model is composed of a TFT-LCD module, a driver circuit, touch panel and a back-light unit. The resolution of a 5.7" contains 640RGB×480 dots and can display up to 262K colors. The following table described the features of MTF-TV57NP721-AV.

1.1 Features

- Transmissive type with LED back-light.
- TN (Twisted Nematic) mode.
- Digital RGB (6bits/color) Data Transfer
- Backlight LED-driving is not built-in this module.

1.2 General Specifications

Item	Specification	Unit
Screen Size	5.7 inches diagonal	--
Display Resolution	640 x RGB x 480	Dot
Pixel Pitch	0.18 (H) × 0.18 (V)	mm
Active Area	115.2 (W) x 86.4 (H)	mm
Outline Dimension	144.0 (W) x 104.6 (H) x 14.3 (T), With touch panel, but without FPCB tail & cable connector of BLU.	mm
Weight	155g (MTF-TV57NN721-AV)	--
	202g (MTF-TV57NP721-AV)	
Display Mode	Normally white/Transmissive/Wide view	--
Pixel Arrangement	RGB-Vertical Stripe	--
Surface Treatment	Non-glare (3H)	--
Viewing Direction	12 O'clock	--
Input Interface	Digital RGB (6bits/color) Data Transfer	--
TFT Driver	Source: Himax HX8250A, Gate: Himax HX8678A	--
Color Garmut	NTSC 50%	--

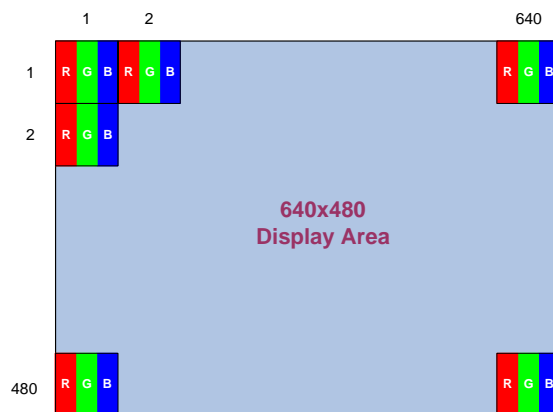

Microtips Technology Inc.

Messrs.					
Product Specification	Model:	MTF-TV57NP721-AV	Rev. No.	Issued Date.	Page.
			<i>B</i>	<i>Oct .16, 07</i>	<i>5 / 29</i>

2. INPUT TERMINAL PIN ASSIGNMENT

2.1 Pin Assignment

Pin No.	Symbol	I/O	Function	Remark
1	DGND	--	GND	--
2	DCLK	I	Clock signal for sampling each data signal	--
3	Hsync	I	Horizontal synchronous signal (Negative)	--
4	Vsync	I	Vertical synchronous signal (Negative)	--
5	GND	I	GND	--
6	R0	I	RED data signal (LSB)	--
7	R1	I	RED data signal	--
8	R2	I	RED data signal	--
9	R3	I	RED data signal	--
10	R4	I	RED data signal	--
11	R5	I	RED data signal (MSB)	--
12	GND	--	GND	--
13	G0	I	GREEN data signal (LSB)	--
14	G1	I	GREEN data signal	--
15	G2	I	GREEN data signal	--
16	G3	I	GREEN data signal	--
17	G4	I	GREEN data signal	--
18	G5	I	GREEN data signal (MSB)	--
19	GND	--	GND	--
20	B0	I	BLUE data signal(LSB)	--
21	B1	I	BLUE data signal	--
22	B2	I	BLUE data signal	--
23	B3	I	BLUE data signal	--
24	B4	I	BLUE data signal	--
25	B5	I	BLUE data signal(MSB)	--
26	GND	--	GND	--
27	DEN	I	Signal to settle the horizontal display position (Positive)	Note5-1
28	V _{CC}	--	+3.3V power supply	--
29	V _{CC}	--	+3.3V power supply	--



Messrs.					
Product Specification	Model:	MTF-TV57NP721-AV	Rev. No.	Issued Date.	Page.
			<i>B</i>	<i>Oct .16, 07</i>	<i>6 / 29</i>

30	LRC	I	Horizontal display mode select signal L: Normal H: Left / Right reverse mode	Note5-2
31	UDC	I	Vertical display mode select signal H: Normal L: Up / Down reverse mode	Note5-2
32	NC	--	No Connection	--
33	GND	I	GND	--

Note5-1 The horizontal display start timing is settled in accordance with a rising timing of ENAB signal. In case ENAB is fixed "Low", the horizontal start timing is determined. Don't keep ENAB "High" during operation.

Note5-2

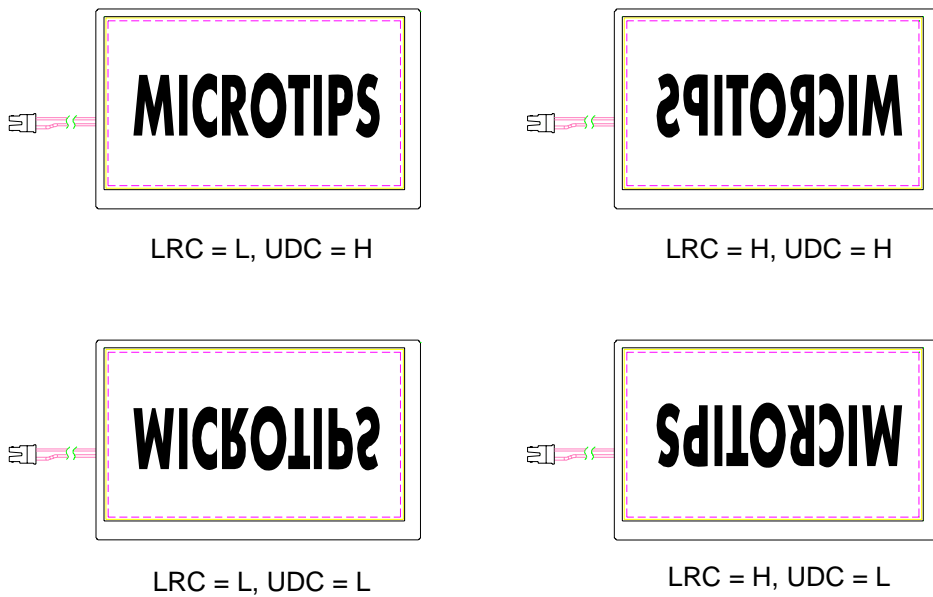

2.2 Back-light Unit (BLU)

Pin No.	Symbol	Function	Wire Color
1	LEDA	Power Supply for LED backlight	Red
2	LEDK	GND for LED backlight	Black

2.3 Touch Panel Pin Assignment

Pin No.	Designation
1	YU
2	XR
3	YD
4	XL



Microtips Technology Inc.

Messrs.					
Product Specification	Model:	MTF-TV57NP721-AV	Rev. No.	Issued Date.	Page.
			<i>B</i>	<i>Oct .16, 07</i>	<i>7 / 29</i>

3. BLOCK DIAGRAM

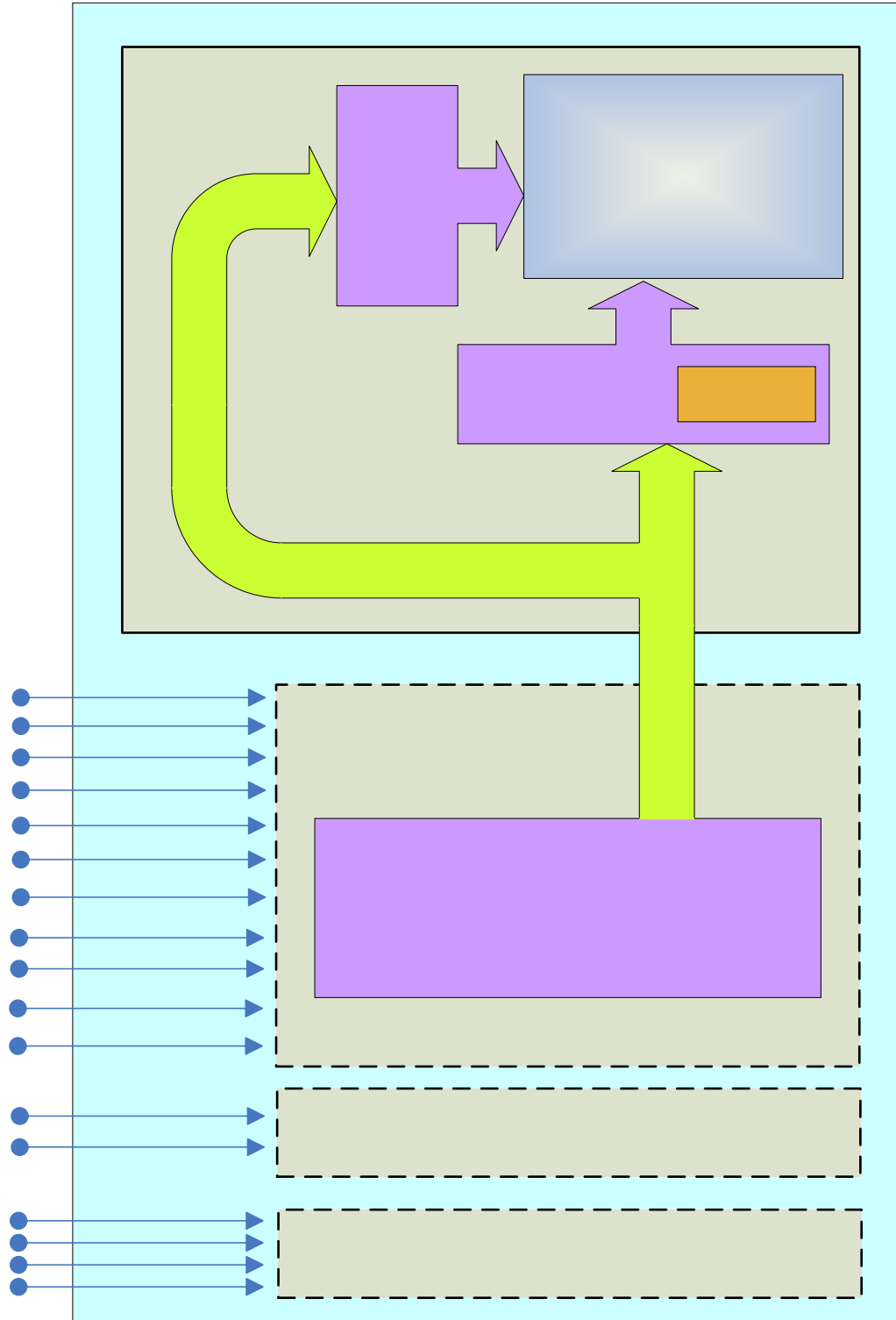

Messrs.					
Product Specification	Model:	MTF-TV57NP721-AV	Rev. No.	Issued Date.	Page.
			<i>B</i>	<i>Oct .16, 07</i>	<i>8 / 29</i>

4. OPTICAL CHARACTERISTICS

The following items are measured under stable conditions. The optical characteristics should be measured in a dark room or equivalent state with the methods shown in Note (1).

Measuring equipment: LCD-5000, BM-5A, BM-7, PR-650, EZ-Contrast

(Ta=25°C , I_F=200mA)

Item		Symbol	Condition	Min	Type	Max	Unit	Note
Brightness	MTF-TV57NN721-AV	Br	I _F =200mA V _F =10.0V	--	450	--	cd/m ²	Note 1
	MTF-TV57NP721-AV			--	360	--	cd/m ²	
Response time		T _r	θ=0°	--	15	20	ms	Note 2
		T _f		--	35	50	ms	
Contrast ratio		CR	At optimized viewing angle	150	250	--	--	Note 3
Color Chromaticity	Red	R _X	θ=0° Normal Viewing Angle	0.585	0.615	0.645	--	--
		R _Y		0.314	0.344	0.374		
	Green	G _X		0.277	0.307	0.337	--	
		G _Y		0.532	0.562	0.592		
	Blue	B _X		0.103	0.133	0.163	--	
		B _Y		0.120	0.150	0.180		
	White	W _X		0.279	0.309	0.339	--	
		W _Y		0.320	0.350	0.380		
Viewing Angle (12 o'clock)	Hor.	θ _R	CR≥10	--	65	--	Degree	Note 4
		θ _L		--	65	--		
	Ver.	θ _B		--	65	--		
		θ _F		--	50	--		
BLU Life time	25°C	LL	I _F =200mA V _F =10.0V	--	50k	--	Hours	Note 5

Note 1 : Definition of Contrast Ratio (CR):

The contrast ratio can be calculated by the following expression.

Contrast Ratio (CR)= L63/L0

L63:Luminance of gray level L63

L0:Luminance of gray level 0

CR=CR(5)

CR(X) is corresponding to the Contrast Ratio of the point X at Figure in Note(5)



Microtips Technology Inc.

Messrs.					
Product Specification	Model:	MTF-TV57NP721-AV	Rev. No.	Issued Date.	Page.
			<i>B</i>	<i>Oct .16, 07</i>	<i>9 / 29</i>

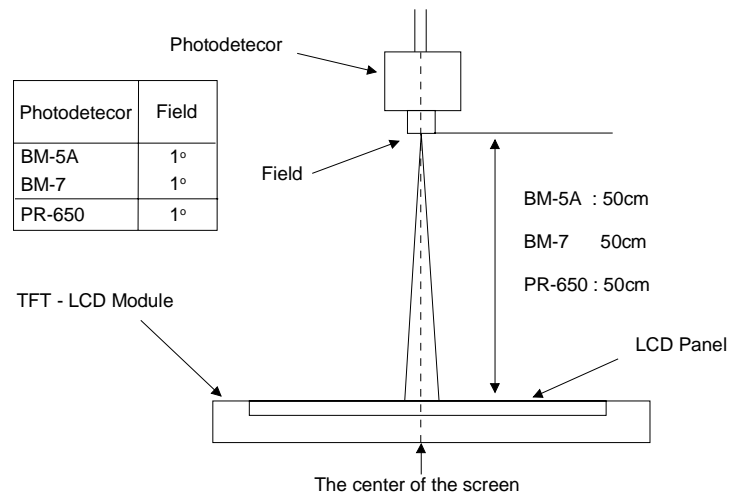

Note 2 : Definition of response time: Tr and Tf

The response time is defined as the following figure and shall be measured by switching the input signal for “black” and “white”.

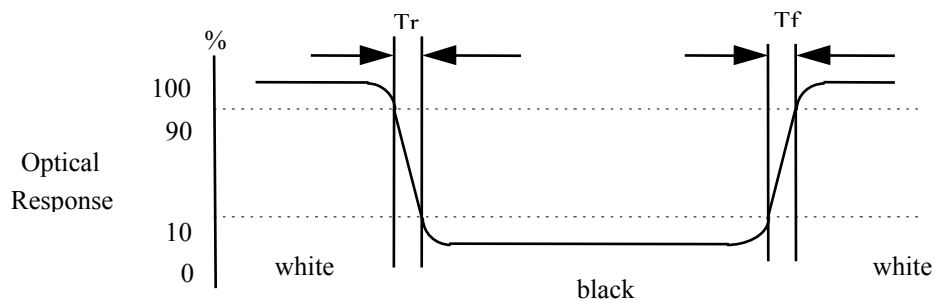

Note 3 : Definition of contrast ratio:

$$\text{Contrast Ratio (CR)} = \frac{\text{Brightness measured when LCD is at "white state"}}{\text{Brightness measured when LCD is at "black state"}}$$

Note 4 : Measured at the center area of the panel when all the input terminals of LCD panel are electrically opened.



Microtips Technology Inc.

Messrs.					
Product Specification	Model:	MTF-TV57NP721-AV	Rev. No.	Issued Date.	Page.
			<i>B</i>	<i>Oct .16, 07</i>	<i>10 / 29</i>

View Angle

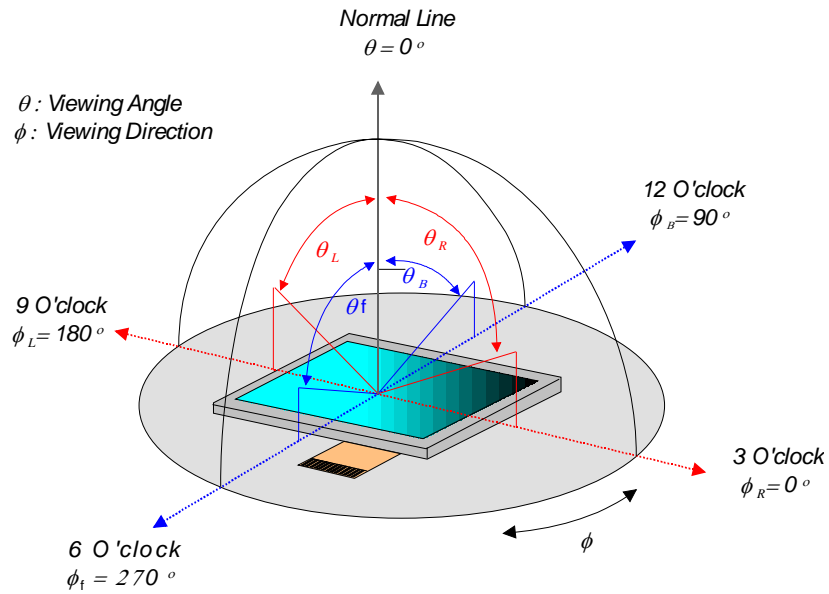

Note 5 : This is the reference value. The white-LED life time is defined as a time when brightness not to become under 50% of the original value (at Ta=25°C)



Microtips Technology Inc.

Messrs.					
Product Specification	Model:	MTF-TV57NP721-AV	Rev. No.	Issued Date.	Page.
			B	Oct .16, 07	11 / 29

5. ABSOLUTE MAXIMUM RATINGS

5.1 Absolute Ratings of Environment

If the operating condition exceeds the following absolute maximum ratings, the TFT LCD module may be damaged permanently.

(Ta=25°C, V_{SS}=GND=0)

Item	Symbol	Min.	Max.	Unit	Note
Storage temperature	T _{STG}	-30	80	°C	(1)
Operating temperature (Ambient temperature)	T _{OPR}	-20	70	°C	(1), (2)

Note (1) 95 % RH Max. (40 °C ≥ Ta)

Maximum wet-bulb temperature at 39 °C or less. (Ta > 40 °C) No condensation.

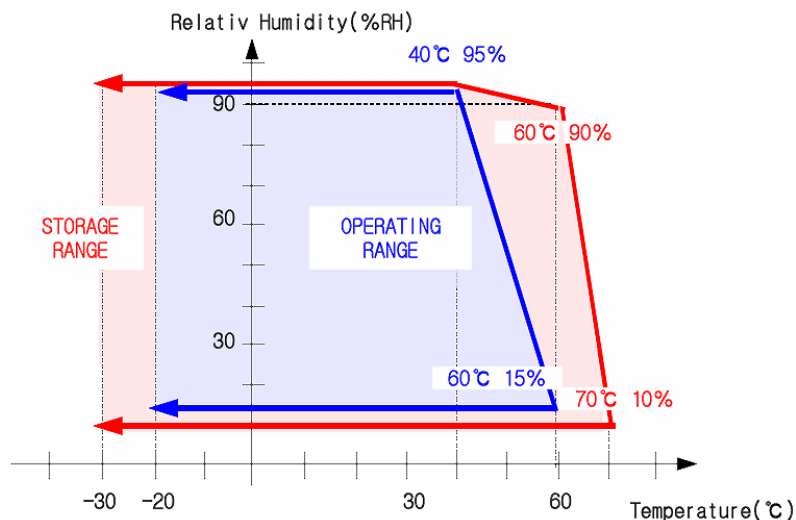

(2) In case of below 0°, the response time of liquid crystal (LC) becomes slower and the color of panel becomes darker than normal one. Level of retardation depends on temperature, because of LC's character

5.2 Electrical Absolute Maximum Rating

(Ta=25°C, V_{SS}=GND=0)

Parameter	Symbol	Min.	Typ.	Max.	Unit	Remark
Power Supply Voltage	V _{CC}	-0.3	--	+7.0	V	Note 1
Logic Output Voltage	V _{OUT}	-0.3	--	+7.0	V	--
Input voltage	V _{IH}	-0.3	--	V _{CC} +0.3	V	--

Note:

(1) All of the voltages listed above are with respect to GND=V_{SS}=0V.



Microtips Technology Inc.

Messrs.					
Product Specification	Model:	MTF-TV57NP721-AV	Rev. No.	Issued Date.	Page.
			<i>B</i>	<i>Oct .16, 07</i>	<i>12 / 29</i>

6. ELECTRICAL CHARACTERISTICS

6.1 DC Electrical Characteristics

($T_a=25\pm 2^\circ\text{C}$, $V_{SS}=\text{GND}=0$)

Item	Symbol	Min.	Typ.	Max.	Unit	Remark	
Supply Voltage	V_{CC}	2.7	3.3	3.6	V	--	
Supply Current	I_{CC}	115	125	135	mA	--	
Input Voltage for logic	L Level	V_{IL}	0	--	$0.3V_{CC}$	V	--
	H Level	V_{IH}	$0.7V_{CC}$	--	$0.3V_{CC}$	V	--
Output low voltage	V_{OL}	0	--	$0.2V_{CC}$	V	$I_{OL}=400\ \mu\text{A}$	
Output high voltage	V_{OH}	$0.8V_{CC}$	--	V_{CC}	V	$I_{OH}=-400\ \mu\text{A}$	



Messrs.					
Product Specification	Model:	MTF-TV57NP721-AV	Rev. No.	Issued Date.	Page.
			<i>B</i>	<i>Oct .16, 07</i>	<i>13 / 29</i>

6.2 AC Timing Characteristic of The LCD

6.2.1 Timing Condition

Parameter	Symbol	Min.	Typ.	Max.	Unit.	Remark
HS setup time	T_{hst}	10	--	--	ns	
HS hold time	T_{hhd}	10	--	--	ns	
VS setup time	T_{vst}	10	--	--	ns	
VS hold time	T_{vhd}	10	--	--	ns	
Data setup time	T_{dsu}	10	--	--	ns	
Data hold time	T_{dhd}	10	--	--	ns	
DEN setup time	T_{esu}	10	--	--	ns	
VS falling to HS falling time on odd field @ RGB mode	T_{HV_O}	-4	0	+4	T_{CPH}	
VS falling to HS falling time on even field @ RGB mode	T_{HV_E}	0.4	0.5	0.6	T_H	
Source output settling time	T_{HF}	--	12	20	μS	
Source output loading R	R_{SL}	--	2	--	K ohm	
Source output loading C	C_{SL}	--	60	--	pF	
POL output delay time	T_{PD}	--	--	40	ns	

6.2.2 Digital Parallel RGB interface(640*3x480 resolution)

Parameter	Symbol	Min.	Typ.	Max	Unit.	Remark
CLK frequency	FCPH	--	25.175	--	MHz	
CLK period	TCPH	--	39.7	--	Ns	
CLK pulse duty	TCWH	40	50	60	%	
HS period	TH	--	800	--	TCPH	
HS period width	TWH	5	30	--	TCPH	
HS-DEN time	THS	112	144	175	TCPH	
DEN pulse width	TEP	--	640	--	TCPH	
VS pulse width	TWV	1	3	5	TH	
VS-DEN time	TSTV	--	35	--	T_H	
VS period	TV	--	525	--	TH	

Note: When SYNC mode is used, 1st data start from 144th CLK after HS falling



Microtips Technology Inc.

Messrs.

Product Specification	Model:	MTF-TV57NP721-AV	Rev. No.	Issued Date.	Page.
			<i>B</i>	<i>Oct .16, 07</i>	<i>14 / 29</i>

6.2.3 Vertical Display Timing

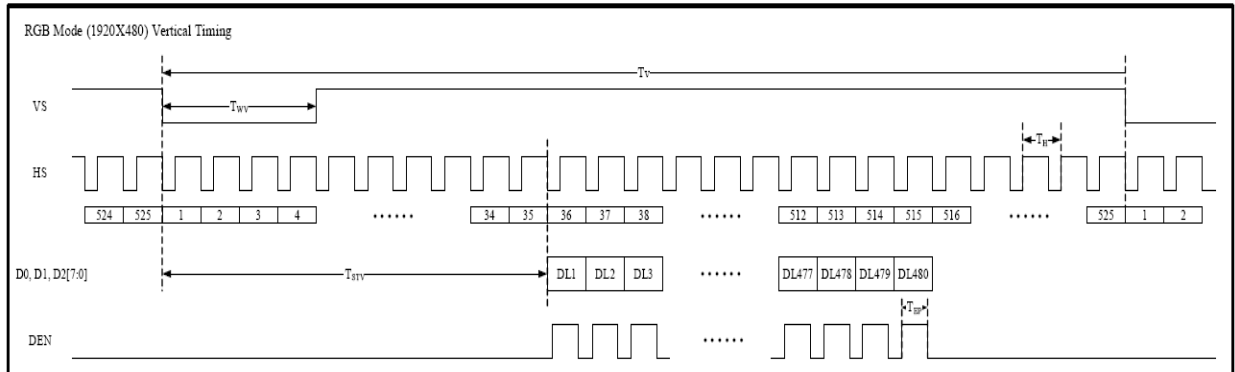

6.2.4 Hsync Timing

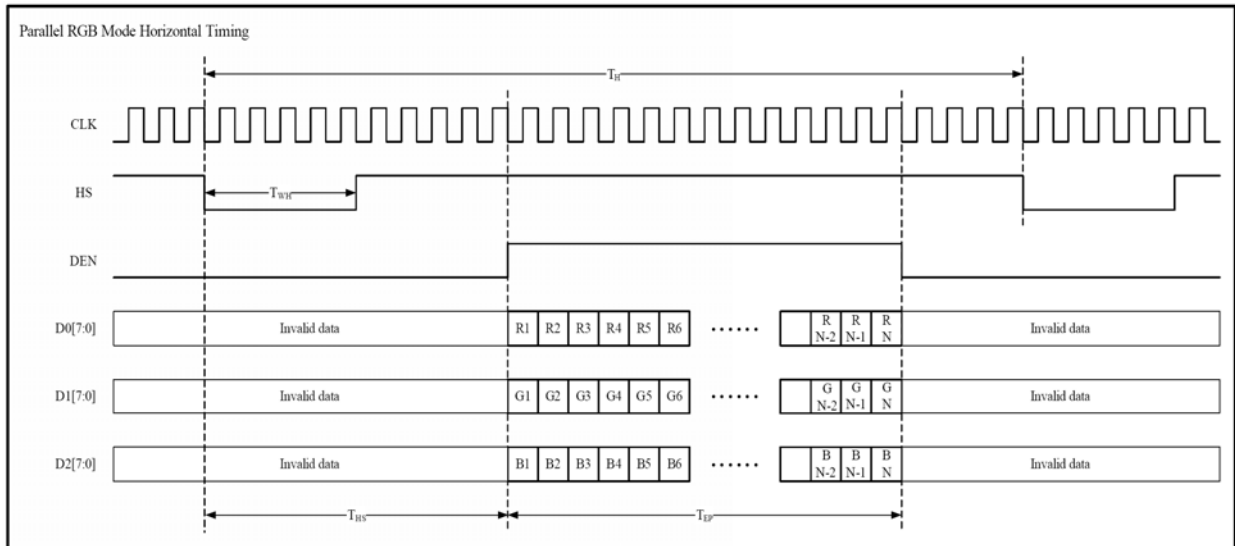

Microtips Technology Inc.

Messrs.					
Product Specification	Model:	MTF-TV57NP721-AV	Rev. No.	Issued Date.	Page.
			B	Oct .16, 07	15 / 29

7. BACKLIGHT SPECIFICATIONS

7.1 Absolute Maximum Ratings

Ta=25°C

Item	Symbol	Maximum rating	Unit	Note
Peak Forward Current	I _{FM}	300	mA	(1)
Reverse Voltage	V _R	15	V	--
Power Dissipation	P _D	3600	mW	--
Operating Temperature	T _{OP}	-20~70	°C	--
Storage Temperature	T _{ST}	-30~80	°C	--

Note (1): Permanent damage to the device may occur if maximum values are exceeded or reverse voltage is loaded.

Functional operation should be restricted to the conditions described under normal operating conditions.

7.2 Electrical/ Operating Characteristic

Ta = 25°C

Parameter	Symbol	Min.	Typ.	Max.	Units	Test Condition
Forward Voltage	V _F	--	10	--	V	Ta=25°C I _F =200mA
LED Current	I _F	--	200	--	mA	
Uniformity*	--	75	--	--	%	
Chromaticity Coordinates	X	0.26	0.29	0.32	--	
	Y	0.26	0.29	0.32	--	

*: Uniformity = (Min./Max.) x 100%

Unregistered HyperSnap

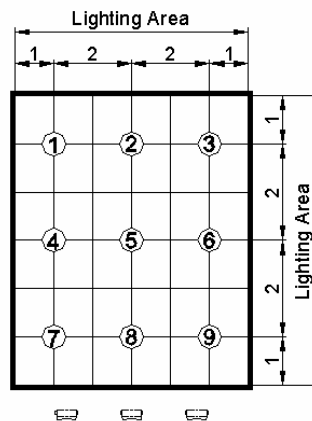

Microtips Technology Inc.

Messrs.					
Product Specification	Model:	MTF-TV57NP721-AV	Rev. No.	Issued Date.	Page.
			B	Oct .16, 07	16 / 29

8. DISPLAYED COLOR AND INPUT DATA

	Color & Gray Scale	Data Signal																	
		R5	R4	R3	R2	R1	R0	G5	G4	G3	G2	G1	G0	B5	B4	B3	B2	B1	B0
Basic Color	Black	1	1	1	1	1	1	1	1	1	1	1	1	1	1	1	1	1	1
	Red(0)	0	0	0	0	0	0	1	1	1	1	1	1	1	1	1	1	1	1
	Green(0)	1	1	1	1	1	1	0	0	0	0	0	0	1	1	1	1	1	1
	Blue(0)	1	1	1	1	1	1	1	1	1	1	1	1	0	0	0	0	0	0
	Cyan	1	1	1	1	1	1	0	0	0	0	0	0	0	0	0	0	0	0
	Magenta	0	0	0	0	0	0	1	1	1	1	1	1	0	0	0	0	0	0
	Yellow	0	0	0	0	0	0	0	0	0	0	0	0	1	1	1	1	1	1
	White	0	0	0	0	0	0	0	0	0	0	0	0	0	0	0	0	0	
Red	Black	1	1	1	1	1	1	1	1	1	1	1	1	1	1	1	1	1	1
	Red(62)	1	1	1	1	1	0	1	1	1	1	1	1	1	1	1	1	1	1
	Red(61)	1	1	1	1	0	1	1	1	1	1	1	1	1	1	1	1	1	1
	:	:	:	:	:	:	:	:	:	:	:	:	:	:	:	:	:	:	:
	Red(31)	1	0	0	0	0	0	1	1	1	1	1	1	1	1	1	1	1	1
	:	:	:	:	:	:	:	:	:	:	:	:	:	:	:	:	:	:	:
	Red(1)	0	0	0	0	0	1	1	1	1	1	1	1	1	1	1	1	1	1
	Red(0)	0	0	0	0	0	0	1	1	1	1	1	1	1	1	1	1	0	
Green	Black	1	1	1	1	1	1	1	1	1	1	1	1	1	1	1	1	1	1
	Green(62)	1	1	1	1	1	1	1	1	1	1	1	0	1	1	1	1	1	1
	Green(61)	1	1	1	1	1	1	1	1	1	1	0	1	1	1	1	1	1	1
	:	:	:	:	:	:	:	:	:	:	:	:	:	:	:	:	:	:	:
	Green(31)	1	1	1	1	1	1	1	0	0	0	0	1	1	1	1	1	1	1
	:	:	:	:	:	:	:	:	:	:	:	:	:	:	:	:	:	:	:
	Green(1)	1	1	1	1	1	1	0	0	0	0	0	1	1	1	1	1	1	1
	Green(0)	1	1	1	1	1	1	0	0	0	0	0	1	1	1	1	1	1	
Blue	Black	1	1	1	1	1	1	1	1	1	1	1	1	1	1	1	1	1	1
	Blue(62)	1	1	1	1	1	1	1	1	1	1	1	1	1	1	1	1	0	1
	Blue(61)	1	1	1	1	1	1	1	1	1	1	1	1	1	1	1	0	1	1
	:	:	:	:	:	:	:	:	:	:	:	:	:	:	:	:	:	:	:
	Blue(31)	1	1	1	1	1	1	1	1	1	1	1	1	1	0	0	0	0	0
	:	:	:	:	:	:	:	:	:	:	:	:	:	:	:	:	:	:	:
	Blue(1)	1	1	1	1	1	1	1	1	1	1	1	1	0	0	0	0	0	1
	Blue(0)	1	1	1	1	1	1	1	1	1	1	1	0	0	0	0	0	0	

0 : Low level voltage, 1 :High level voltage

Each basic color can be displayed in 64 gray scales from 6 bit data signals. With the combination of total 18 bit data signals, the 262,144-color display can be achieved on the screen.



Microtips Technology Inc.

Messrs.					
Product Specification	Model:	MTF-TV57NP721-AV	Rev. No.	Issued Date.	Page.
			<i>B</i>	<i>Oct .16, 07</i>	<i>17 / 29</i>

9. QUALITY STANDARD FOR LCD

9.1 Objective

This specification book is the standard for LCD module general inspection. And also this book will be refer to customer approval specification.

9.2 Scope

This specification book is applicable to general LCD module. If supplier has any doubt or requirement, then it can be discussed.

9.2.1 Acceptable Quality Level

INSPECTION	SAMPLING PROCEDURES	A.Q.L
Major	MIL-STD-105E Inspection Level II Normal Inspection Single sample inspection	1
Minor	MIL-STD-105E Inspection Level II Normal Inspection Single sample inspection	1.5

Major defect :

A major defect is a defect that could result in failure or extremely reduction on the usability of the product for its intended purpose.

Minor defect :

A minor defect is one that does not materially reduce the usability of the product for its intended purpose or is a departure from established standards giving no significant bearing on the effective use or operation of the unit.

9.2.2 Inspection Conditions

9.2.2.1 The environmental conditions for inspection shall be as follows

- Room Temperature : 25±10°C
- Humidity Temperature : 45±20%RH

9.2.3 The external visual inspection

- The inspection shall be performed by using 40Watts fluorescent lamp for illumination and the distance between LCD and eyes of the inspector shall be 30cm or more.



Messrs.					
Product Specification	Model:	MTF-TV57NP721-AV	Rev. No.	Issued Date.	Page.
			<i>B</i>	<i>Oct .16, 07</i>	<i>18 / 29</i>

9.2.4 Inspection Item

Pinhole, Bright spot, Black spot, White spot, Black line, White Line, Foreign particle, Bubble	The color of a small area is different from the remainder. The phenomenon dose not change with voltage.
Contrast variation	The color of a small area is different from the remainder. The phenomenon change with voltage.
Glass defect	Glass crack, Chip
Operating	Function, Contrast, Uniformity, Components

9.2.5 Definition of the Area

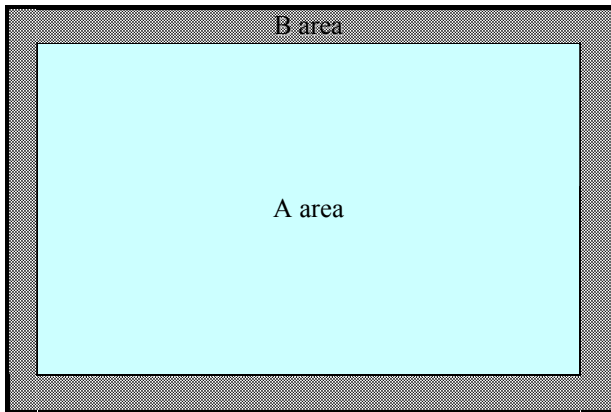

A area: Viewing Area
 B area: Out of Viewing Area



Messrs.					
Product Specification	Model:	MTF-TV57NP721-AV	Rev. No.	Issued Date.	Page.
			B	Oct .16, 07	19 / 29

9.3 Inspection specification

9.3.1 Non-operating inspection specification

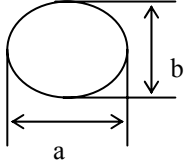
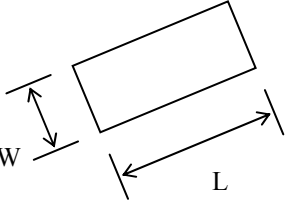
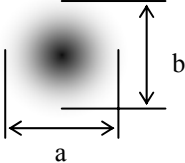
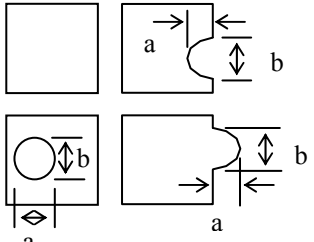
Class of defects	No.	Inspection Item	Criteria of defects		Acceptable Q'ty			
					Zone A	Zone B		
Major	1	Circuits	1. Circuit short		0	0		
			2. Circuit open					
Minor	2	Black spot, White spot, Bright spot, Foreign particle  $\phi = (a+b)/2$	A	$\phi \leq 0.3$	Ignore			
			B	$0.3 < \phi \leq 0.4$	4			
			C	$0.4 < \phi \leq 0.5$	2			
			D	$0.5 < \phi$	0			
			Total defect point (B,C)		4		Ignore	
			* Reject when 5 or more spots are gathered within 5mm circle.					
	3	Black line, White line 	A	$W \leq 0.02$	--	*		
			B	$0.02 < W \leq 0.05$	$L \leq 5$	2		
			C	$0.05 < W \leq 0.1$	$L \leq 3$	2		
			D	$0.1 < W$	--	0		
			Total defect point (B,C)		3		Ignore	
			* Reject when 5 or more spots are gathered within 5mm circle.					
4	Contrast variation  $\phi = (a+b)/2$	A	$\phi \leq 0.3$	Ignore				
		B	$0.3 < \phi \leq 0.4$	4				
		C	$0.4 < \phi \leq 0.5$	2				
		D	$0.5 < \phi$	0				
		Total defect point (B,C)		4		Ignore		
		* Reject when 5 or more spots are gathered within 5mm circle.						
5	attern deformity  $\phi = (a+b)/2$	1. Pin hole		Ignore				
		A	$\phi \leq 0.15$			Ignore		
		B	$0.15 < \phi \leq 0.2$			2 (*)		
					$0.2 < \phi$	0		
		* Two pin hole shall not formed in the single dot						
				2. Excess, void				
A	$a \leq 0.2$ & $b \leq 0.2$	Ignore		Ignore				
B	$0.2 < a$ or $0.2 < b$	0						



Messrs.					
Product Specification	Model:	MTF-TV57NP721-AV	Rev. No.	Issued Date.	Page.
			B	Oct .16, 07	20 / 29

Minor	6	Dot defect	A	Bright dot	$N \leq 2$	Ignore
			B	Dark dot	$N \leq 3$	
			C	Total Bright & Dark Dots	$N \leq 4$	
			* This inspection item does not apply to B/W LCD			
	7	Bubble between Polarizer and panel	A	$\phi \leq 0.3$	Ignore	Ignore
			B	$0.3 < \phi \leq 0.5$	2	
			C	$0.5 < \phi$	0	
	8	Polarizer scratch and particle	Circular : Same as inspection item No.2			Ignore
			Linear : Same as inspection item No.3			
	9	Polarizer Dent	A	$\phi \leq 0.2$	Ignore	Ignore
			B	$0.2 < \phi \leq 0.3$	4	
			C	$0.3 < \phi \leq 0.4$	2	
			D	$0.4 < \phi$	0	
			Total defect point (B,C)		3	
	10	Bubble in the Cell	Any size		0	0
11	Dirt on polarizer	Dirt which can be wiped easily should be accepted.				
12	Protection film	The protection film should not be stripped up to viewing area and the peeled off angle should not exceed 20 degrees.				
13	Polarizer shift	<ol style="list-style-type: none"> Shifting in position should not exceed the glass outline dimension. Incomplete covering of the viewing area due to shifting is not allowed. Shifting in position should be within the tolerance (refer to module dimensional drawing) 				
14	Silicon	<ol style="list-style-type: none"> Silicon must cover all circuits. Silicon thickness should be within specification (refer to module dimensional drawing) 				
15	Tape	<ol style="list-style-type: none"> Location: refer to specification. Insufficient adhesive. 				
Major	16	TCP, FPC defect	Film or Pattern should not have crack.			
	17	Components	Missing components not allowed.			



Messrs.					
Product Specification	Model:	MTF-TV57NP721-AV	Rev. No.	Issued Date.	Page.
			<i>B</i>	<i>Oct .16, 07</i>	<i>21 / 29</i>

Class of defects	No.	Inspection Item	Criteria of defects
Major	1	No display	--
	2	Abnormal operation	--
	3	Contrast defect	Judge according to module specification. Establish boundary sample if required.
	4	Viewing angle defect	Judge according to module specification. Establish boundary sample if required.
	5	Excess power consumption	Judge according to module specification.
	6	Back-light, LED defect	1. No lit-on 2. Different color 3. Low brightness
	7	Speaker, Vibrator defect	1. No operation 2. Abnormal operation
Minor	8	Cross-talk defect	No noticeable crosstalk. Establish boundary sample if required.
	9	Uneven brightness	No noticeable unevenness allowed. Establish boundary sample if required.
	10	Uneven color	No noticeable unevenness allowed. Establish boundary sample if required.
	11	Spot, Pinhole, Foreign particle, Line	Same as in Chapter 7.1



Messrs.					
Product Specification	Model:	MTF-TV57NP721-AV	Rev. No.	Issued Date.	Page.
			<i>B</i>	<i>Oct .16, 07</i>	<i>22 / 29</i>

10. RELIABILITY CONDITION FOR LCD

10.1 Reliability Test Condition

No.	TFT	Item	Condition	Test time	Note
1	V	High temp. operating	80°C	240 Hrs	--
2	V	Low temp. operating	-30°C	240 Hrs	--
3	V	High temp. storage	70°C	240 Hrs	--
4	V	Low temp. storage	-20°C	240 Hrs	--
5	V	High Temp / High Humidity Storage	Ta = 60°C /90% (But no condensation dew)	240 Hrs	--
6	V	High Temp/ High Humidity Operating	T = 60°C /90% For (But no condensation dew)	240 Hrs	--
7	V	Thermal Shock	-20 ~ 70°C	50 cycles	--

Note: Reliability Test Criteria:

- All judgments of display are performed after temp of panel returns to room temperature
- Display function should be no change under normal operating condition.
- Under no condensation of dew
- Each cycle: -20°C(30min) -25°C -70°C (30min) -25°C

↑ ↑
 5 (min)

10.2 Operating Test Pattern

No.	Items	Test Pattern
1	Test Pattern in Driving Condition	1. Full Red 2. Full Green 3. Full Blue 4. Gradation (horizontal) 5. Gradation (vertical) 6. Character (111111) 7. Full White 8. Full Black 9. Black Line (horizontal) 10. Black Line (vertical) 11. Mosaic (1X1) The Test Pattern is changed 1sec. The same Pattern are repeated.
2	Black Square	Black Window and White Background



Messrs.					
Product Specification	Model:	MTF-TV57NP721-AV	Rev. No.	Issued Date.	Page.
			<i>B</i>	<i>Oct .16, 07</i>	<i>23 / 29</i>

10.2.1 Test Method

The method of visual inspection is equal to the appearance standard. Evaluation and assessment made two hours after return to room temperature ($25 \pm 5^{\circ}\text{C}$). The LCDs subjected to the test must not have dew condensation.

The test pattern is gray scale and the operating voltage sweep from V_{th} to V_{sat} variable.

The non-uniformity and other appearance are checked in LCD.

10.2.2 Result Evaluation Criteria

There should be no change which might affect the practical display function when the display quality test is conducted under normal operating condition.

10.2.3 Life time

Life time expectancy of LCD Panel is approximately 50,000 hours under the room environment. Definition on the termination of life time is deterioration of contrast ratio by one fifth against initial value.

10.2.4 Basic rule for Reliability test

- * Place all the samples under room temperature & humidity for 24 hours after reliability stressing.
- * Room environment means $25 \pm 10^{\circ}\text{C}$, $45 \pm 20\% \text{RH}$
- * There should be no condensation during the test.
- * One LCD module shall be used for one test item only and once.

10.2.5 Judgment Criteria for reliability test No. 1-2

- * Contrast (or Brightness) ratio variation is within 50% of the initial value.
- * No abnormal function
- * No extreme decay on appearance

10.2.6 Life time

Main Display (LCD module) : Life time expectancy of LCD Panel is approximately 50,000 hours under the room environment.

Definition on the termination of life time is deterioration of contrast ratio by one fifth against initial value. ($25 \pm 10^{\circ}\text{C}$, $45 \pm 20\% \text{RH}$). Life time shall be defined as one of below cases;

- When the contrast ratio for Main display reaches 30% of initial condition and the brightness (or luminance with polarizer) for sub display reaches 50% of initial condition.
- When the appearance degradation appears.



Messrs.					
Product Specification	Model:	MTF-TV57NP721-AV	Rev. No.	Issued Date.	Page.
			<i>B</i>	<i>Oct .16, 07</i>	<i>24 / 29</i>

10.3 Touch Panel Reliability

No.	Items	Min.	Typ.	Max.	Unit	Remark
1	Activation Force	100	130	150	g	1. within active area. 2. R0.8mm polyacetal pen or R8.0mm finger.
2	Surface Hardness	3	--	--	H	Judgment ref. JIS-K5600
3	Durability (Writing Life)	100,000	--	--	characters	1. within active area. 2. R0.8mm polyacetal pen. 3. Load: 150g 4. Speed: 60mm/sec
4	Durability (Hitting Life)	1,000,000	--	--	touches	1. within active area. 2. R8.0mm silicon rubber. 3. Load: 250g 4. Frequency: 3 times/sec



Messrs.					
Product Specification	Model:	MTF-TV57NP721-AV	Rev. No.	Issued Date.	Page.
			<i>B</i>	<i>Oct .16, 07</i>	<i>25 / 29</i>

11. PRECAUTIONS





11.1 Operation

Burn-in sometimes happens when the same character was displayed at along time. Therefore, to prevent Burn-in, it is recommended to set up a Screen-saver function.

11.2 Safety





The liquid crystal in the LCD is poisonous, DO NOT put it in your mouth. If the liquid crystal touches your skin or clothes, wash it off immediately using soap and water.

11.3 Handling

	<p>a. The LCD module shall be installed flat, without twisting or bending.</p> <p>b. COF or FPC has narrow pattern width, so easily become open circuit by external force. DO NOT apply pressure to COF or FPC especially in bending area.</p>
	<p>c. To avoid damage in appearance or malfunction, DO NOT subject the module to mechanical shock or to excessive force on its surface.</p>
	<p>d. The polarizer attached to the display is very easy to be damaged, handle it with care to avoid scratching.</p>
	<p>e. To avoid contamination on the display surface, DO NOT touch the display surface with bare hands.</p> <p>f. Provide a space so that the LCD module does not come into contact with other components.</p>

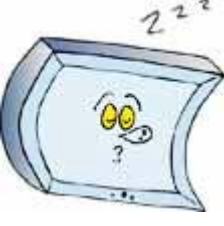
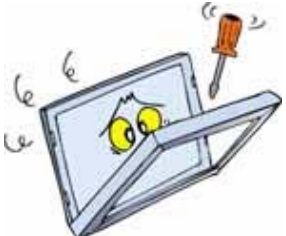

Messrs.					
Product Specification	Model:	MTF-TV57NP721-AV	Rev. No.	Issued Date.	Page.
			<i>B</i>	<i>Oct .16, 07</i>	<i>26 / 29</i>

	<p>g. To protect the LCD panel from external pressure, put covering glass (acrylic board or similar board) to keep appropriate space between them.</p>
	<p>h. Be careful for condensation at sudden temperature change. Condensation makes damage to polarizer or electrical contacted parts. And after fading condensation, smear or spot will occur.</p>
	<p>i. Property of semiconductor devices may be affected when they are exposed to light possibly resulting in malfunctioning of the ICs. To prevent such malfunctioning of the ICs, your design and mounting layout done are so that the IC is not exposed to light in actual use.</p>
	<p>j. Strong light exposure causes degradation of color filter. It may not recover</p>
	<p>k. DO NOT contact with water to avoid Metal corrosion.</p> <p>l. When it is not in use, the screen must be turned off or the pattern must be frequently changed by a screen saver. If it displays the same pattern for a long period of time, brightness down/image sticking may develop due to the LCD structure.</p>
	<p>m. Never disassemble LCD product under any circumstances. If unqualified operators or users assemble the product after disassembling it, it may not function or its operation may be seriously affected.</p>



Messrs.					
Product Specification	Model:	MTF-TV57NP721-AV	Rev. No.	Issued Date.	Page.
			<i>B</i>	<i>Oct .16, 07</i>	<i>27 / 29</i>

11.4 Static electricity

Since a module is composed of electronic circuits, it is not strong to electrostatic discharge.

	<ol style="list-style-type: none"> The LCD module shall be installed flat, without twisting or bending. Ground soldering iron tips, tools and testers when they operate. Ground your body when handling the products. DO NOT apply voltage to the input terminal without applying power supply. DO NOT apply voltage that exceeds the absolute maximum rating. Store the products in an anti-electrostatic container. Peel off protect tape, attached to polarizer, slowly to minimize ESD damage.
---	--

11.5 Storage

	<p>Store the products in a dark place at +5 ~ +25 degree C, low humidity (50%RH or less). DO NOT store the products in an atmosphere containing organic solvents or corrosive gases.</p>
---	--

11.6 Cleaning

	<ol style="list-style-type: none"> DO NOT wipe the polarizer with dry cloth, as it might cause scratch. Wipe the polarizer with a soft cloth soaked with petroleum IPA, other chemical might damage.
---	--

11.7 Waste

	<p>When dispose of LCD module, manage it at the production waste according to the relevant laws and regulations.</p>
---	--



Messrs.					
Product Specification	Model:	MTF-TV57NP721-AV	Rev. No.	Issued Date.	Page.
			<i>B</i>	<i>Oct .16, 07</i>	<i>28 / 29</i>

12. WARRANTY

This product has been manufactured to your company's specifications as a part for use in your company's general electronic products. It is guaranteed to perform according to delivery specifications. For any other use apart from general electronic equipment, we cannot take responsibility if the product is used in medical devices, nuclear power control equipment, aerospace equipment, fire and security systems, or any other applications in which there is a direct risk to human life and where extremely high levels of reliability are required. If the product is to be used in any of the above applications, we will need to enter into a separate product liability agreement.

- 1 We cannot accept responsibility for any defect, which may arise from additional manufacturing of the product (including disassembly and reassembly), after product delivery.
- 2 We cannot accept responsibility for any defect, which may arise after the application of strong external force to the product.
- 3 We cannot accept responsibility for any defect, which may arise due to the application of static electricity after the product has passed your company's acceptance inspection procedures.
- 4 We cannot accept responsibility for industrial property, which may arise through the use of your product, with exception to those issues relating directly to the structure or method of manufacturing of our product. Microtips-origin longer than one year from Microtips production.

13. DIMENSIONAL OUTLINES

See next page.



Microtips Technology Inc.

